

# Mirto Outdoor

TABLES

2013

Antonio Citterio



## Description

---

Ein Klassiker ist geboren der die stabile Eleganz seines Autors entspricht. Verschiedene Produkten gehören zu dieser Kollektion: Stühlen, Sessel und eine Liege mit verstellbaren Rücklehne. Der Klappstuhl bearbeitet den klassischen Regisseur-Stuhl neu, mit neuen und sorgfältigen Details. Tische, Beistelltische und Konsole haben dieselbe Gestelle aber die Platte in Blech lackiert, mit Iroko natur gebürstet Daube oder aus Porzellan-Steinzeug weiß Calacatta.

## Technical information

---

**Gestell**

Aluminiumguss und fließgepresstes Aluminium mit Polyurethanlackierung

**Platte**

Aluminiumblech mit Polyurethanlackierung, Porzellan-Steinzeug oder Lavastein emailliert auf Aluminiumplatte

**Gleiter**

Elastomer thermoplastisch

**Wetterfeste Abdeckung**

Polyesterstoff auf einer PU-Seite

# Technical drawings

---

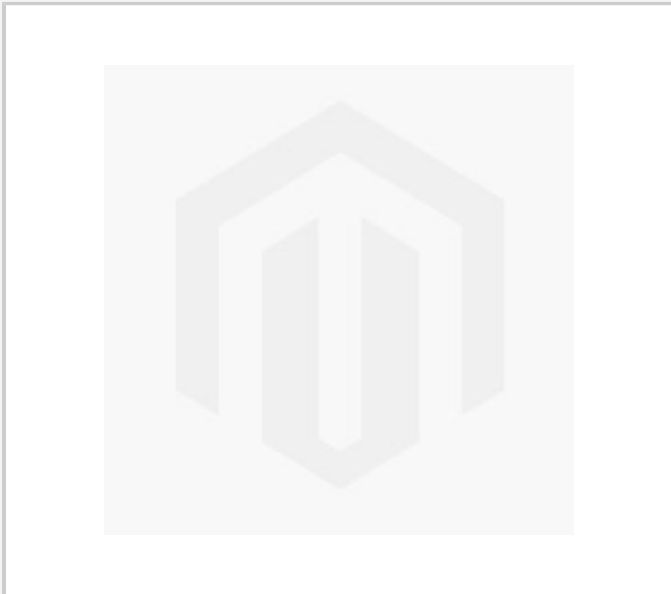
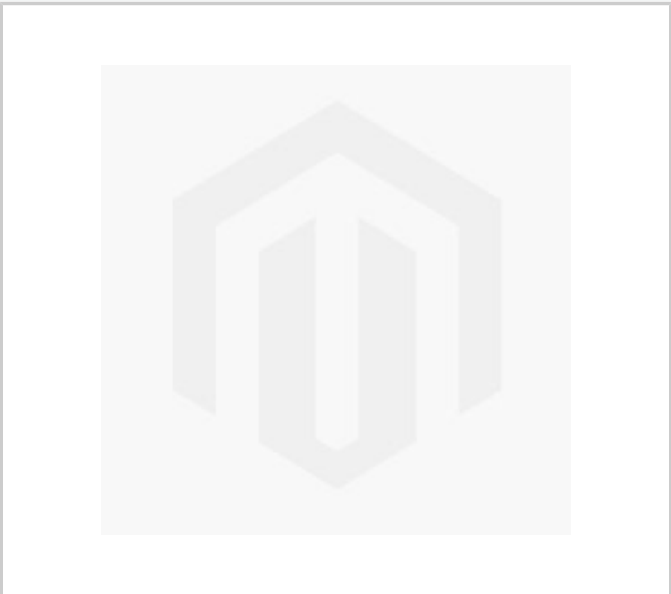

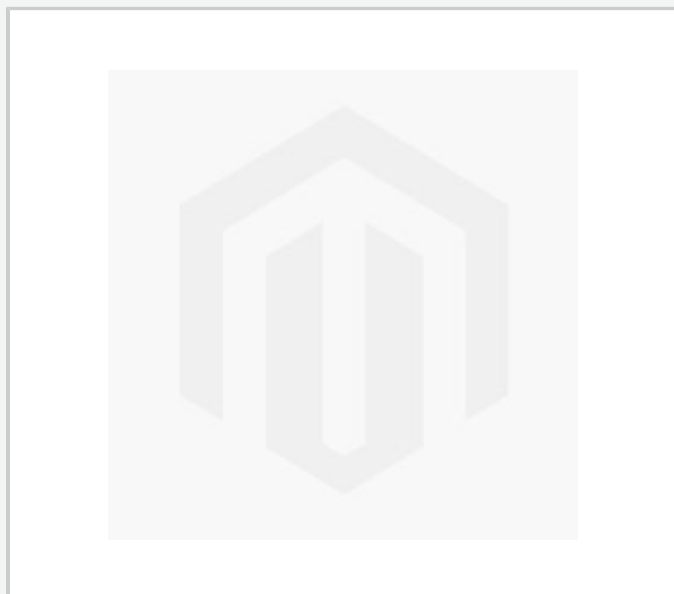
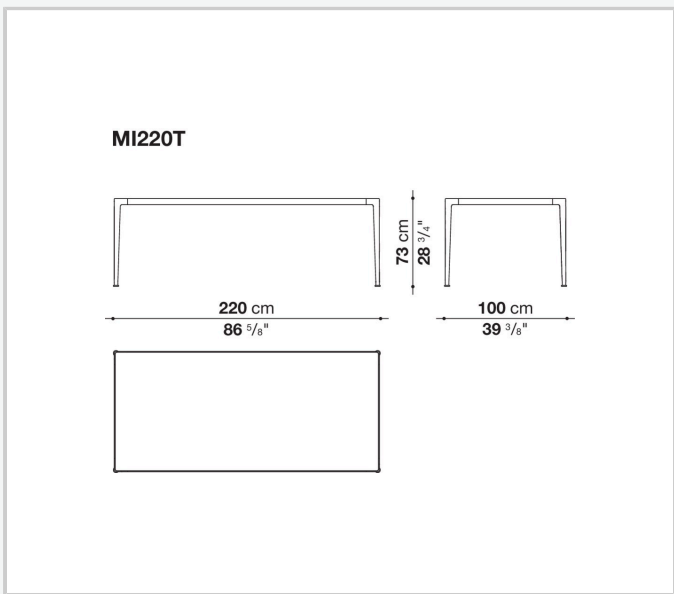
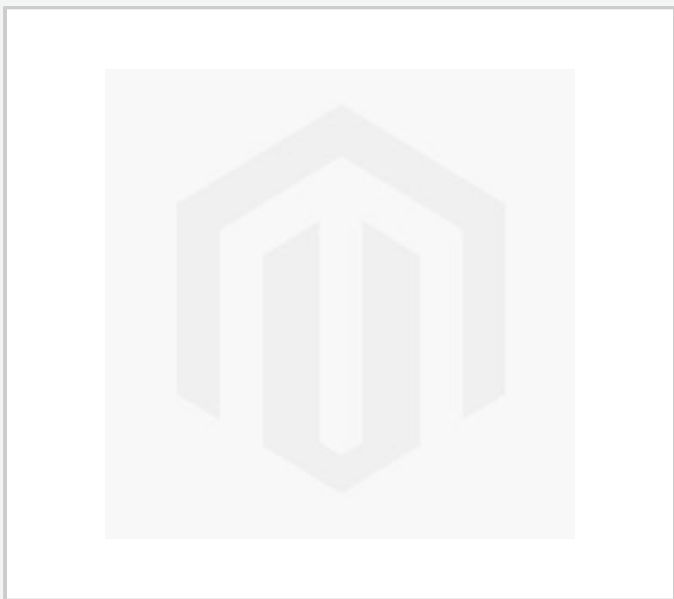
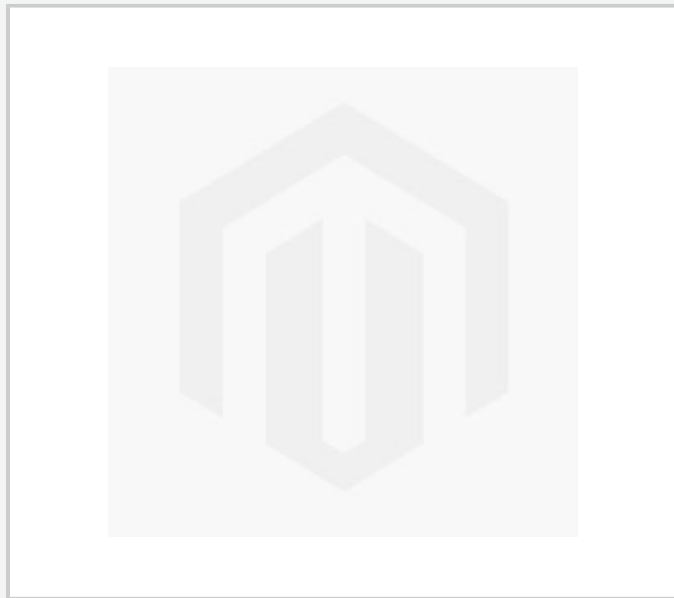
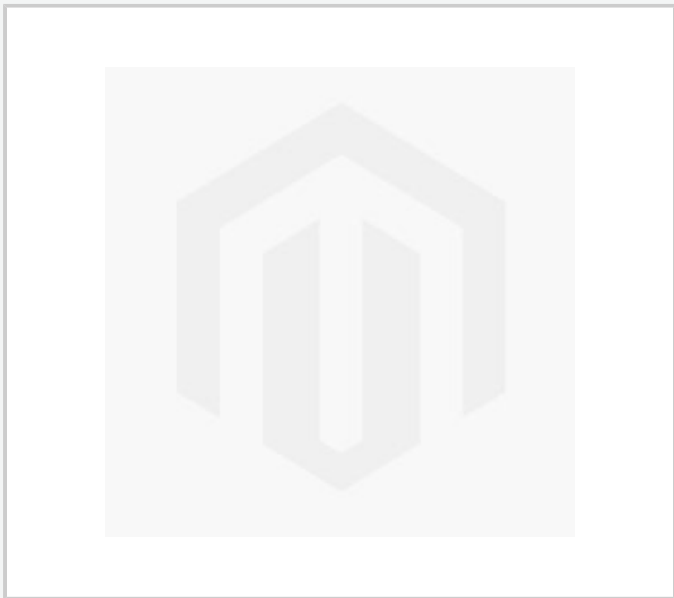

MI220TG

