

---

# Ribes

SOFAS

2019

Antonio Citterio



## Description

---

Ribes is a modular seating system that focuses on versatility, customisation, colour and research into materials. Sofas, central and end elements, chaise longues and ottomans all come in a huge variety of shapes and sizes that lend themselves to being arranged in an outdoor space according to personal taste thanks to the exceptional versatility of the modular components and the availability of a vast range of covers and finishes. The starting point is a futon base with flexible glass fibre slats resting on an aluminium frame to which two types of armrest or backrest can be attached as desired: one with a polypropylene fibre interlacing, the other with a roller cushion. On top are seat cushions intended as comfortable mattresses to stretch out on and several shapes of back and armrest cushion, all containing a new upholstery giving Ribes a particularly lived-in and soft look. Because it is so versatile, Ribes can also be reconfigured over time by adding new elements, as well as by altering the functional use of existing ones. By substituting, adding or varying the position of the back and armrests, a sommier can turn into a vis-à-vis sofa, a sofa can become an island, and a corner seating plan can transform into a comfortable bed. Ribes means transformation and is especially suited to those areas that are neither inside nor outside: verandas, shady patios, under a loggia or on a covered terrace, allowing a fluid approach to the open spaces in the home.

## Technical information

---

**Frame**

die-cast aluminium and extrusions with polyester powder painting

**Back and roller upholstery**

polyester fiber recycled from PET, cover in water repellent polyester fibre

**Seat upholstery**

shaped polyurethane, polyester fiber recycled from PET, cover in water repellent polyester fibre

**Interlacing**

polypropylene fibre braid

**Seat slats**

glass fibre

**Seat top section**

solid wood

**Ferrules**

thermoplastic material

**Waterproof cover cloth**

PES fabric coated on one side in PU

**Cover**

fabric in limited categories (with profile)

# Technical drawings

---

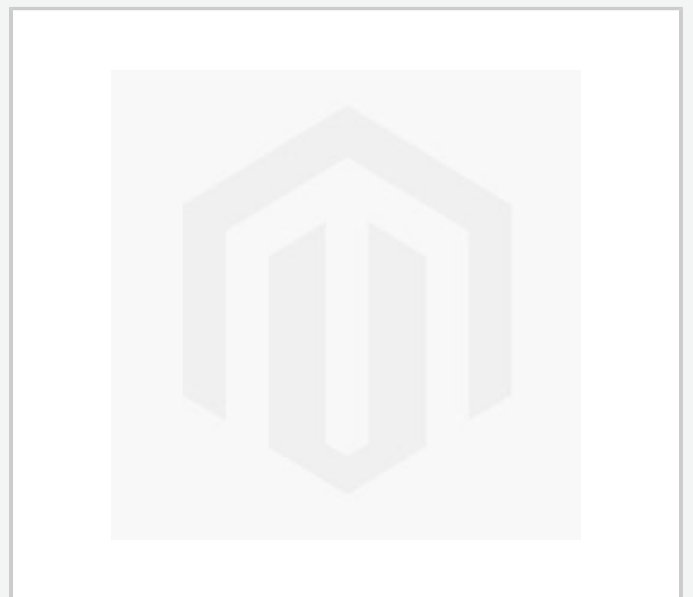
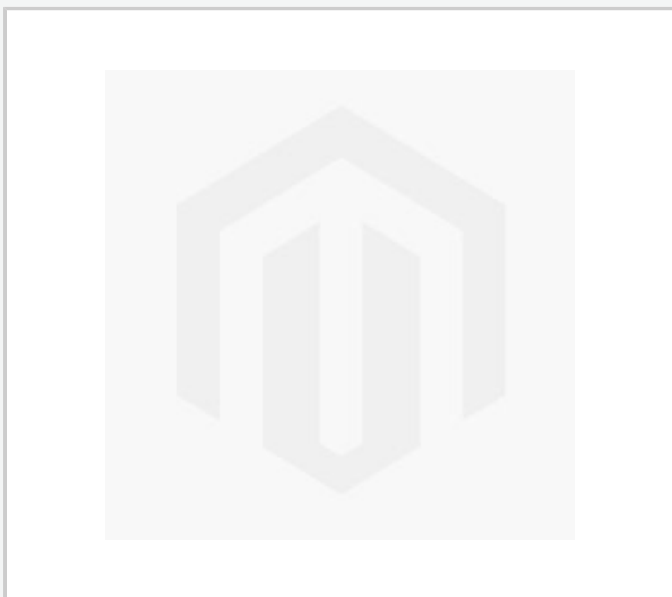

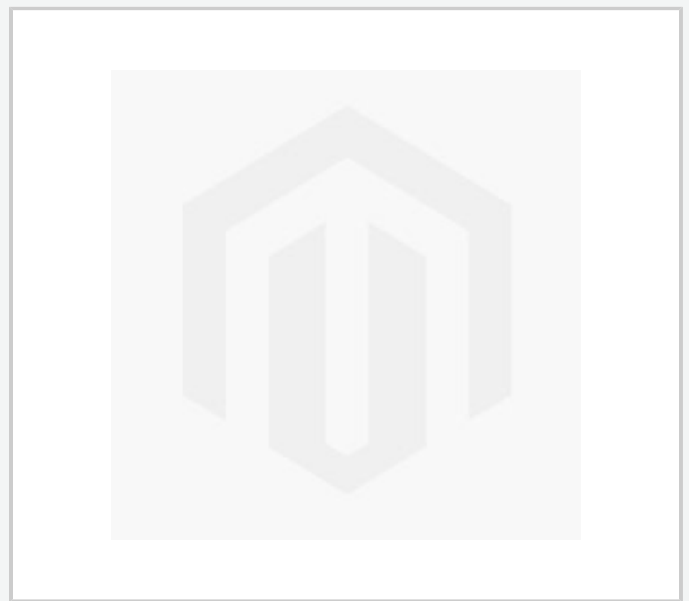
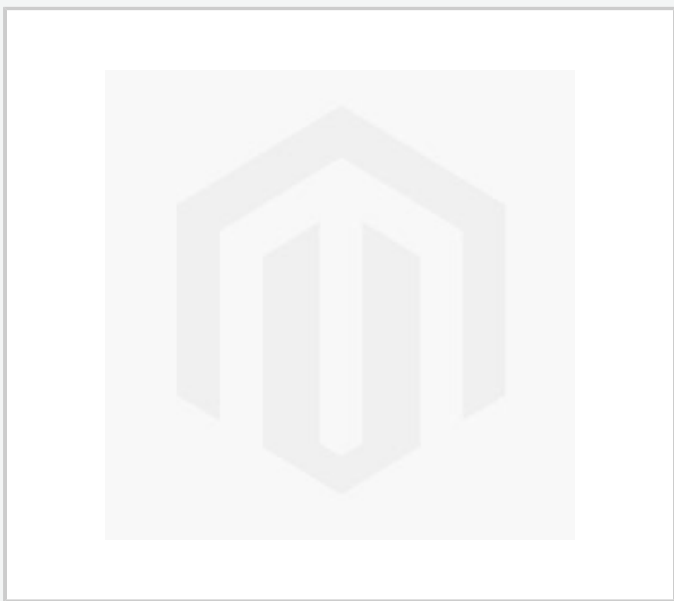
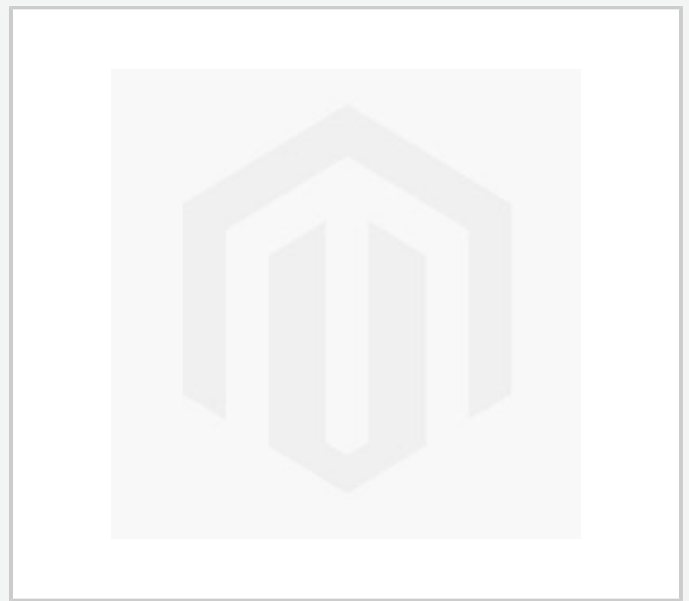
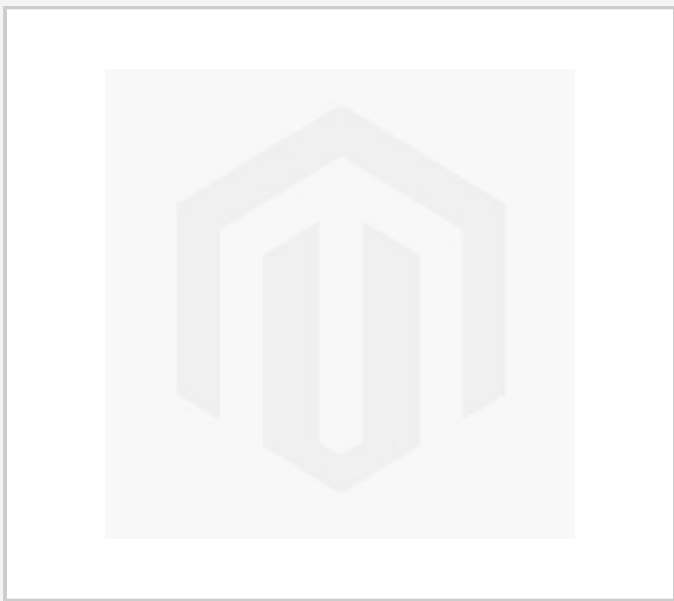

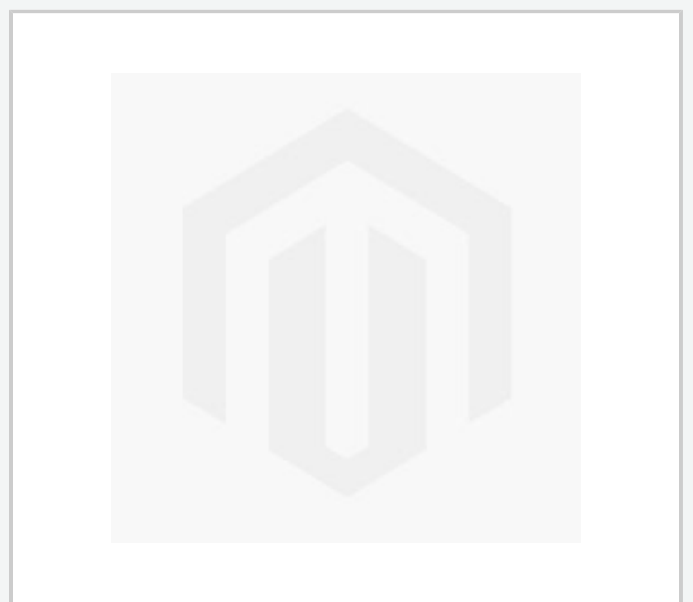
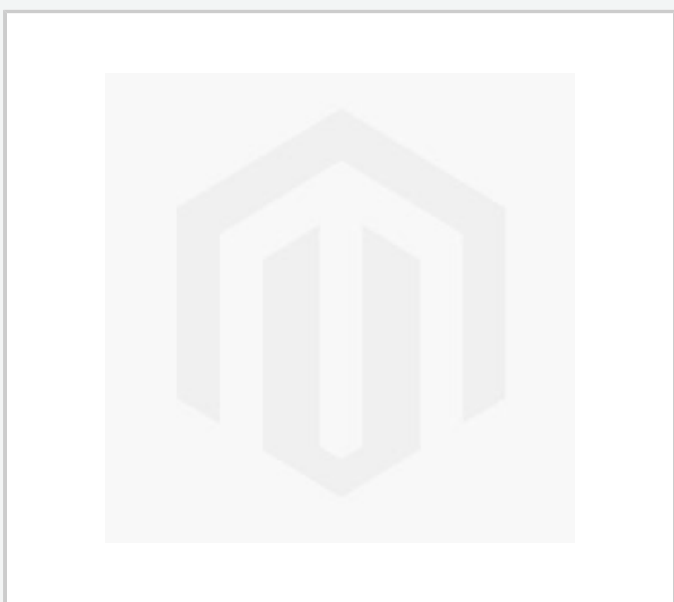
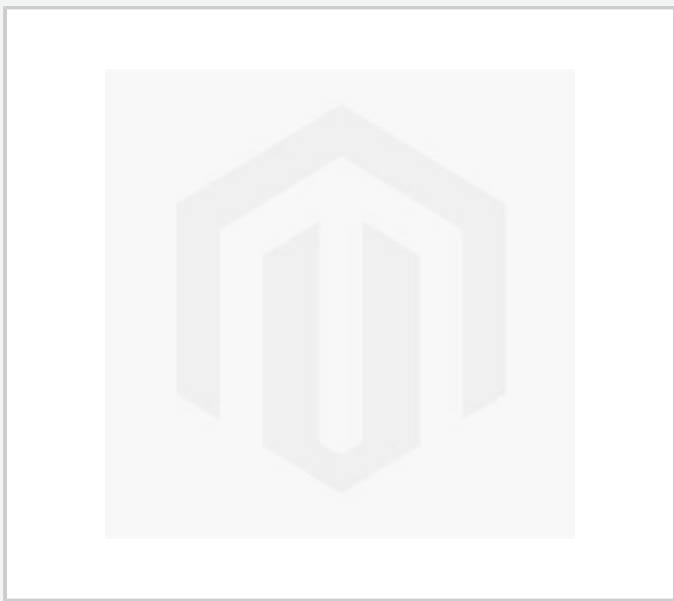

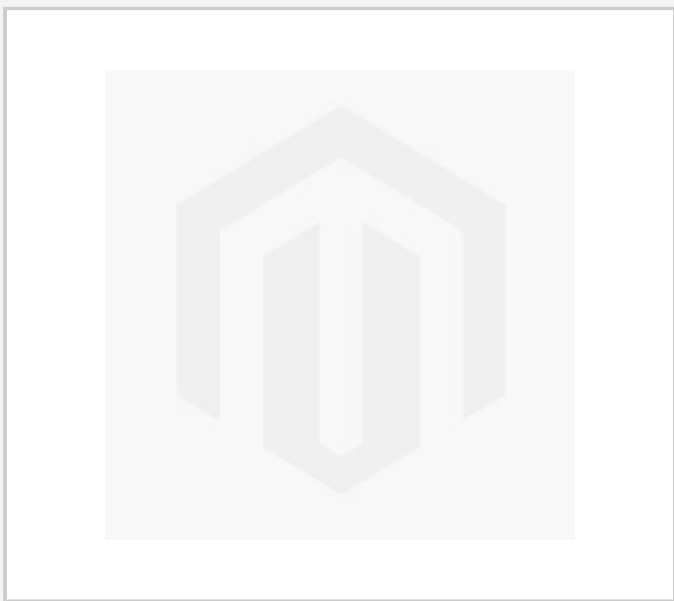
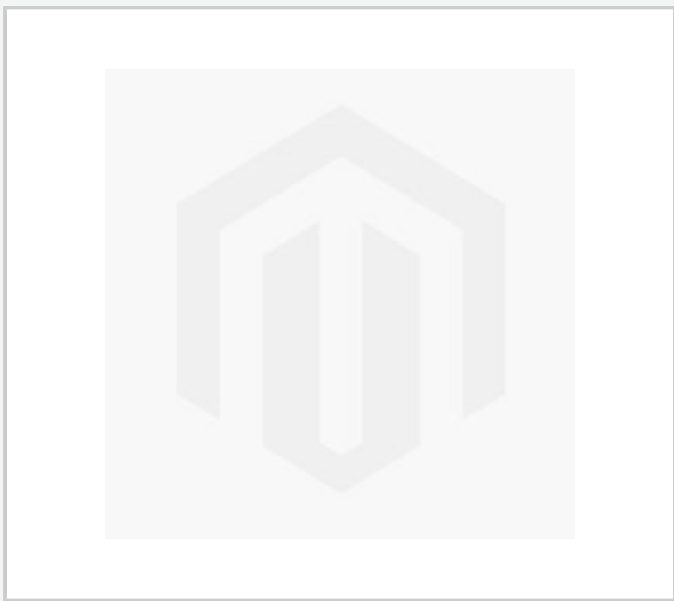
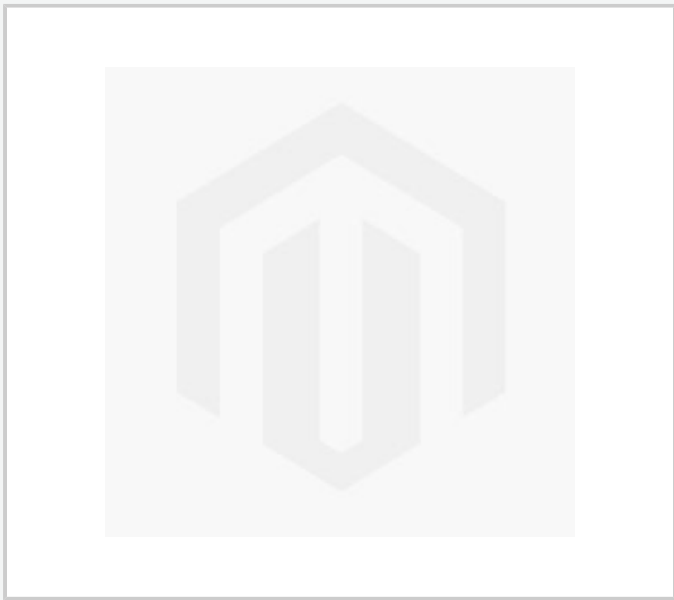

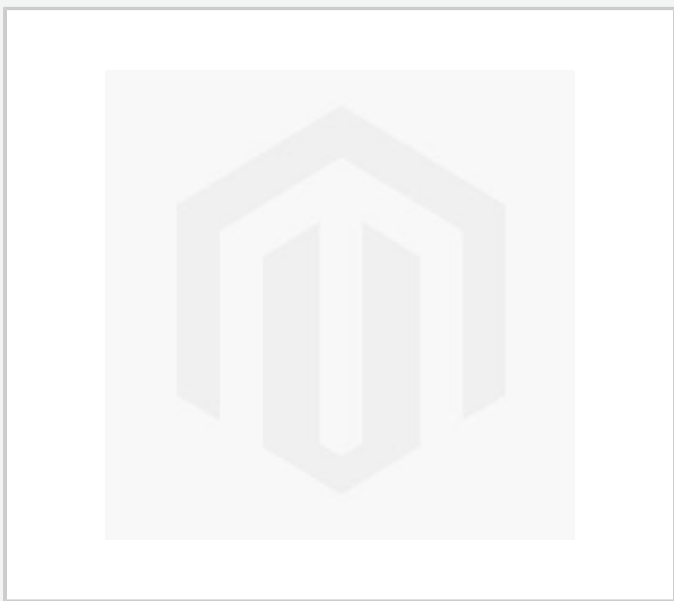
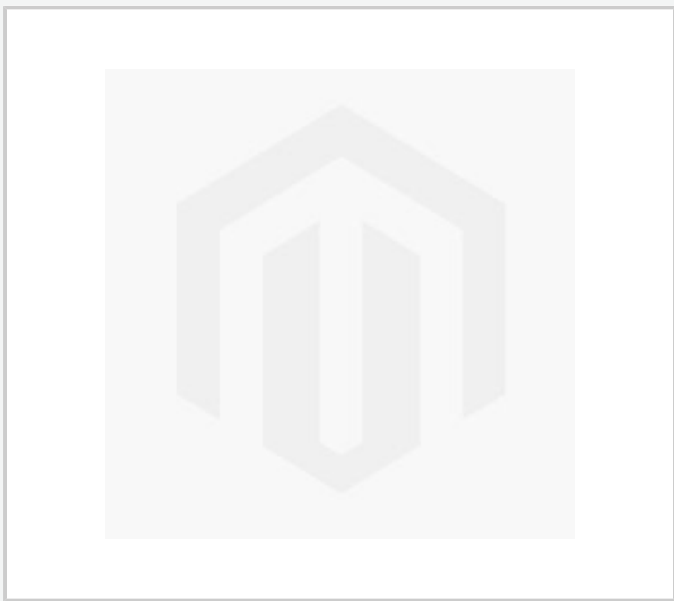
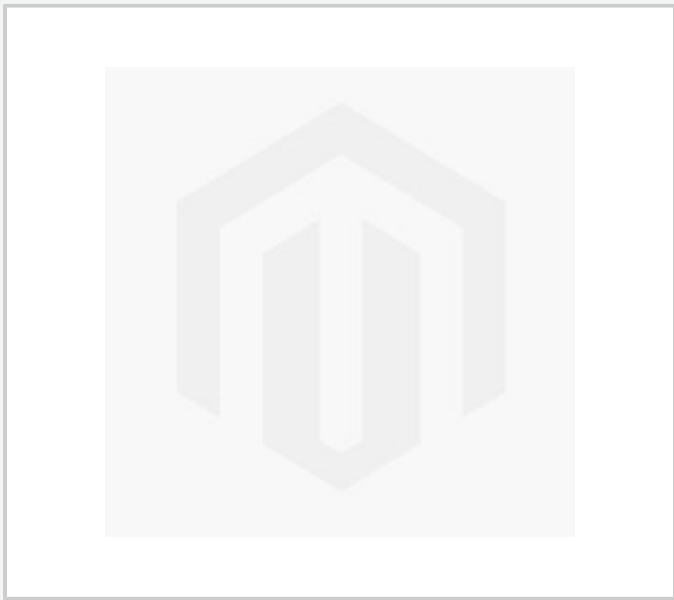

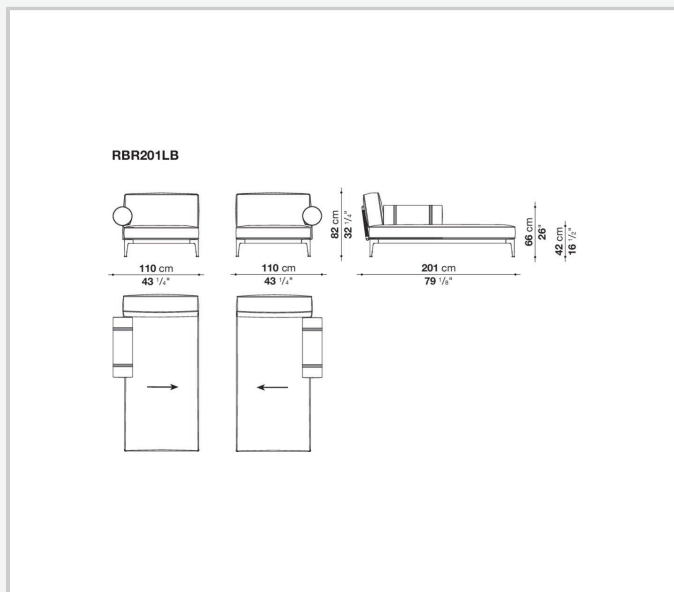
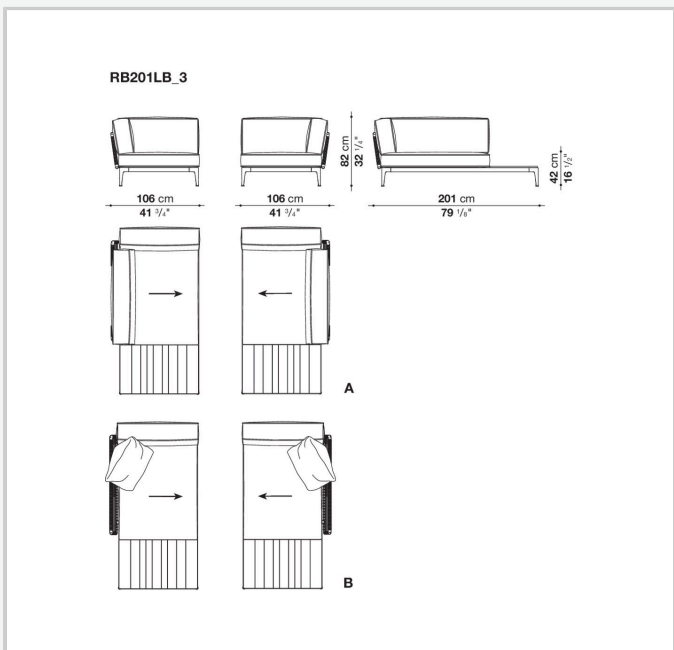
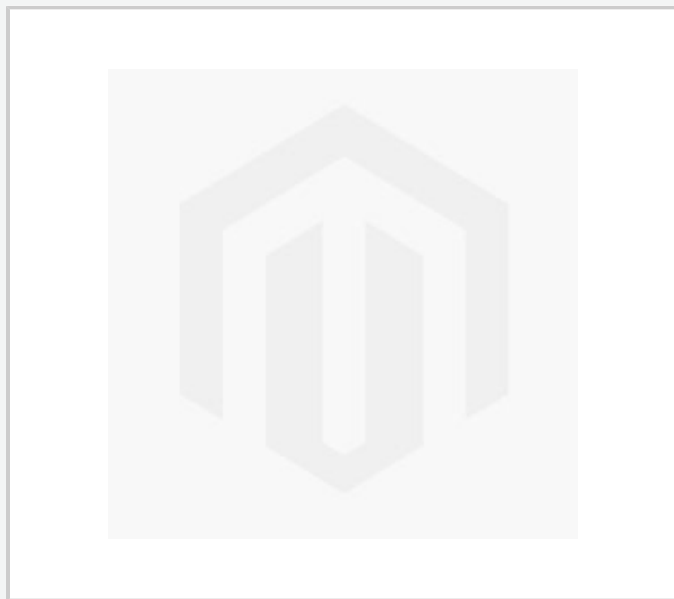
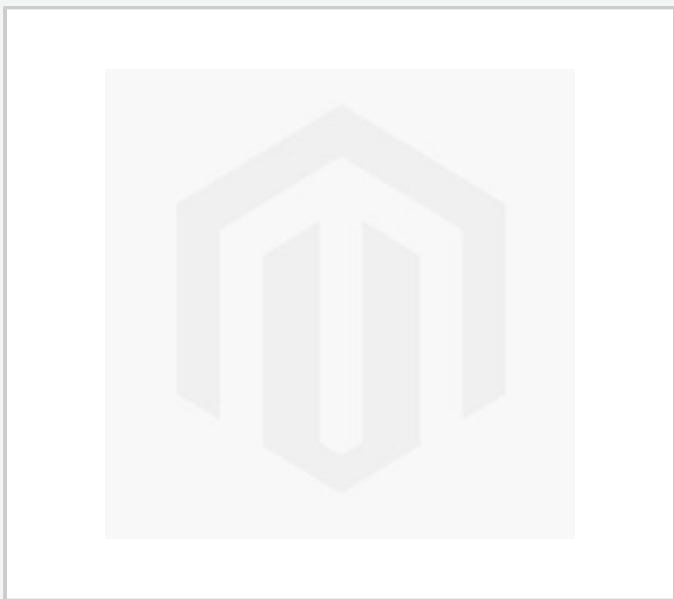
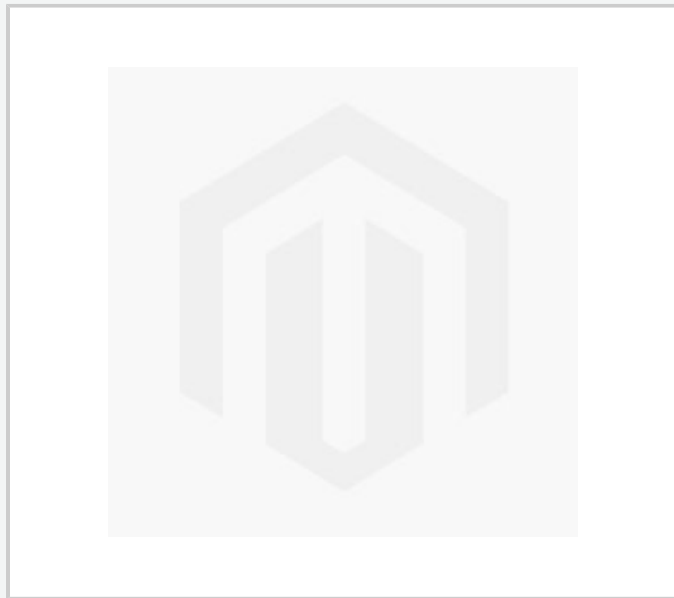
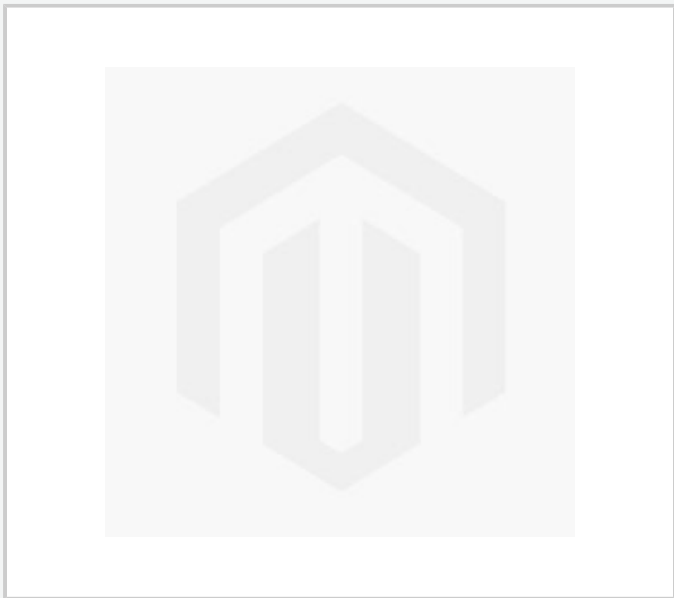



RB201LB\_2

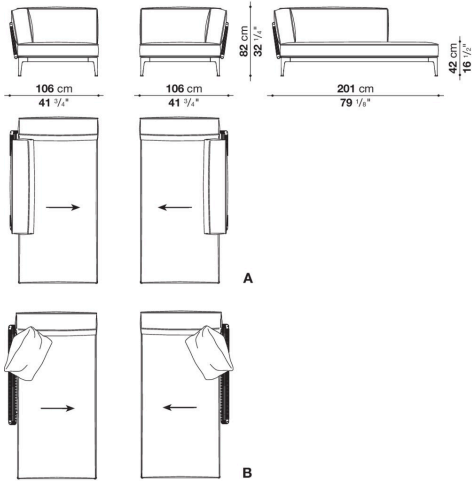

RB141LB\_2

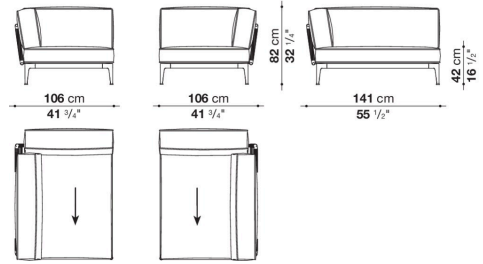

RB141LB\_4

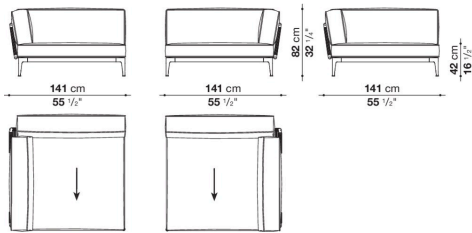

RB141LB\_6

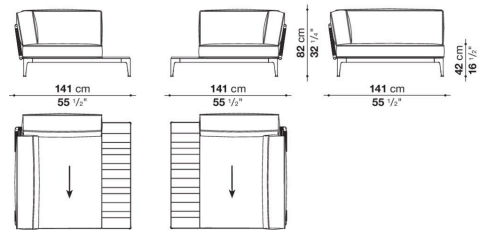

RB130P\_1

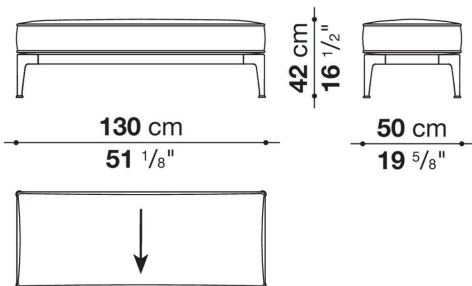

RB130P\_2

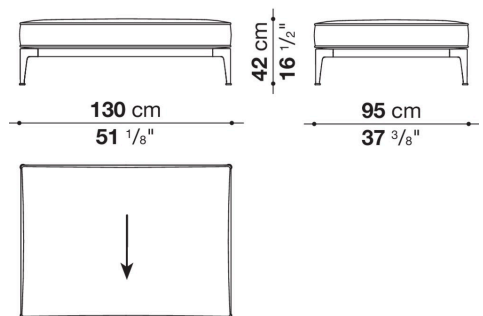

**RB130PQ**

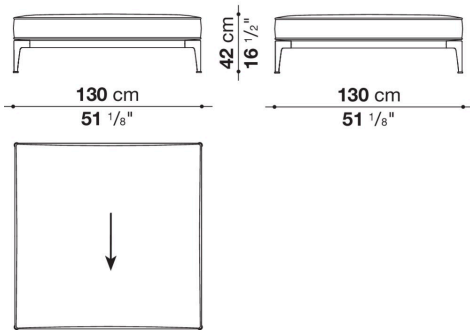

**RB130PQ\_1**

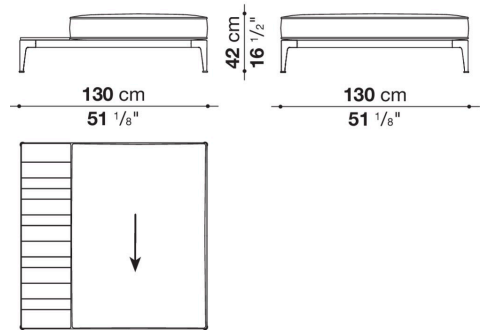

**RB190P**

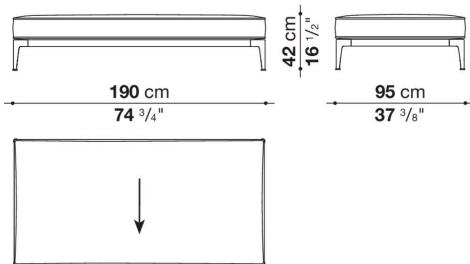

**RB190P\_1**

