

# Mirto Outdoor

TAVOLI

2013

Antonio Citterio



## Description

---

The Mirto Outdoor tables are characterised by their purity of shape, timeless elegance and quality details. Available in numerous sizes and two heights, they come with light die-cast aluminium frames and a variety of tops: in painted aluminium, porcelain stoneware, and glazed lava stone tiles decorated with reproductions of traditional Sicilian lace. This latest version uses a special material for the decoration, obtained by shattering the glass of monitors and discarded electronic instruments, and applying it to the surface of the tiles through an exclusive manufacturing process. Mirto Outdoor is a complete series of outdoor furniture inclusive of chairs, small armchairs, loungers, small tables, consoles and other furnishings.

## Technical information

---

**Frame**

die-cast aluminium and extrusions with polyurethane painting

**Top**

aluminium sheet with polyurethane painting, porcelain stoneware or enamelled lava stone on aluminium top

**Ferrules**

thermoplastic elastomer

**Waterproof cover cloth**

PES fabric coated on one side in PU

# Technical drawings

---

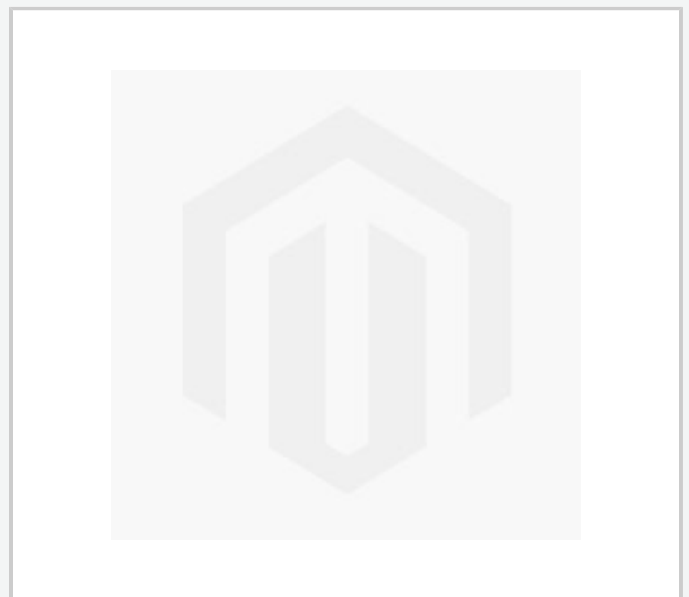

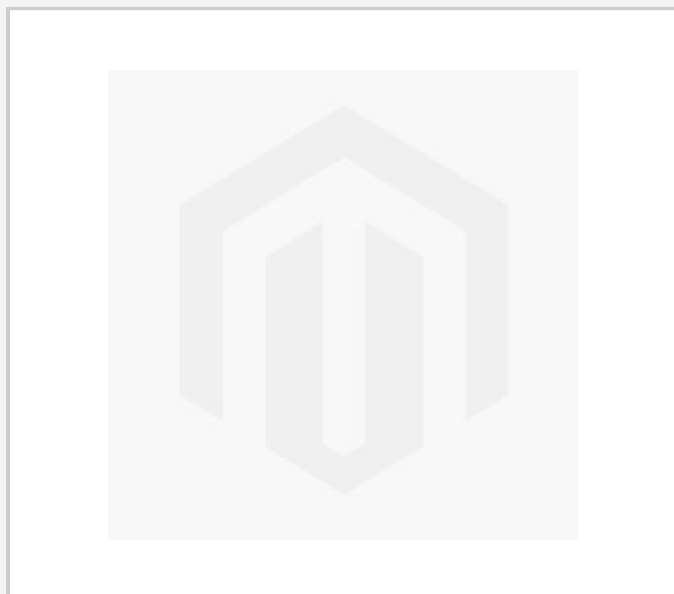
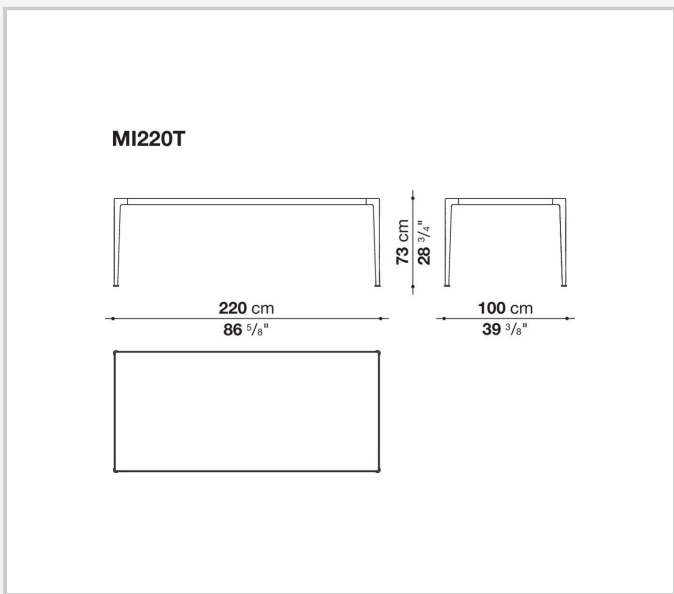
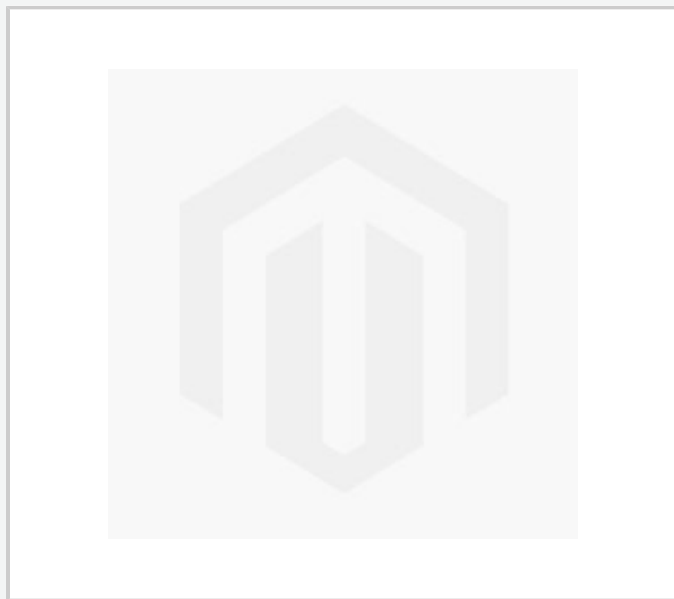
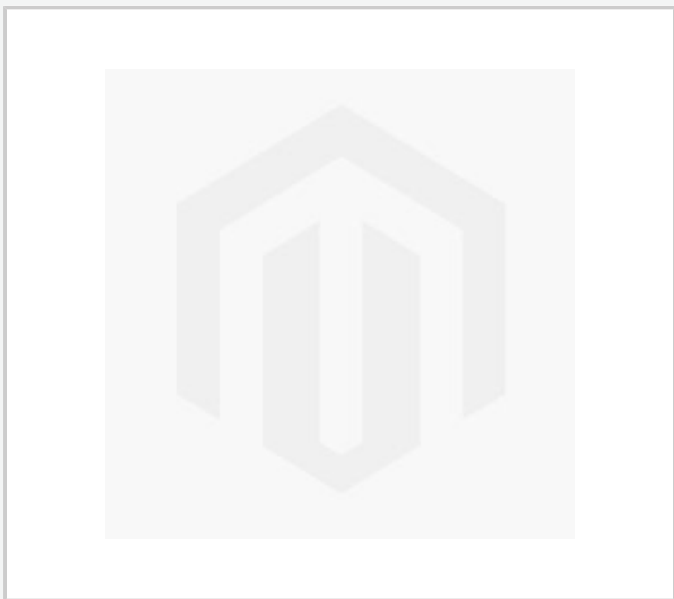
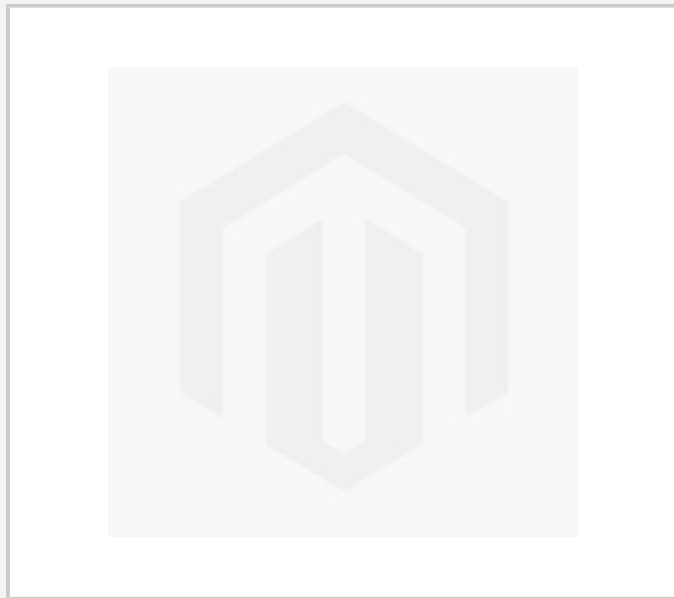
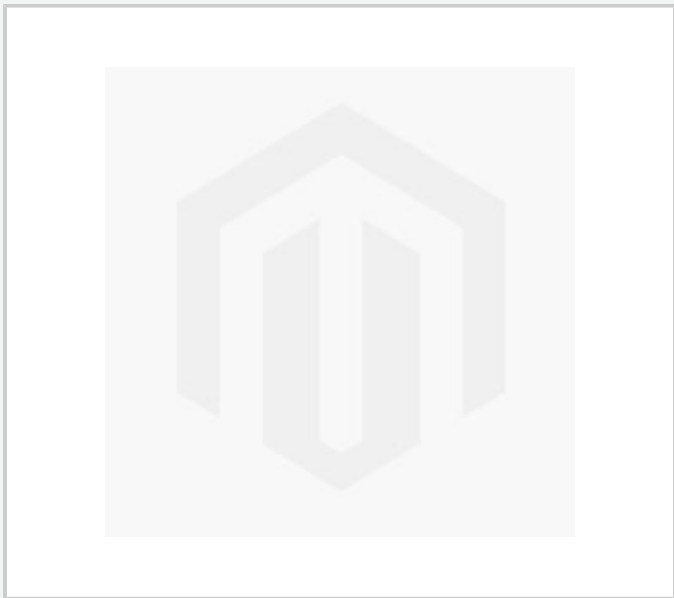

MI220TG

