

# Saké

SOFAS

2017

Piero Lissoni



## Description

---

Saké is a strongly contemporary seating system distinguished by a careful search for formal balance. The idea behind the line is a basic platform, magically suspended in the air like a flying carpet, with cushions to enclose the borders and feet to ground it. The seats, in three sizes, come with embracing or linear backs and armrests of various dimensions, added harmoniously to create a sofa adapted to the customer's space and personal taste. The details of the cushions and support base contribute to the design's lightness. The seat cushion has refined modular stitching; the back cushions, available in two sizes, are outlined by profiled bands. The support base is made of crosspieces with rounded steel feet connected to each other by a bar. The system also offers a sofa bed, adopting the other sofas' seating and back elements.

## Technical information

---

**Internal frame**

tubular steel and steel profiles

**Seat, back and armrest upholstery**

Bayfit® flexible cold shaped polyurethane foam, polyester fibre cover

**Back cushion (SK50C-SK75C)**

combination of polyester fibre and visco-elastic polyurethane, polyester fibre cover, box style typology

**Support frame**

steel

**Ferrules**

thermoplastic material

**Cover**

fabric or leather

# Technical drawings

**SK250**

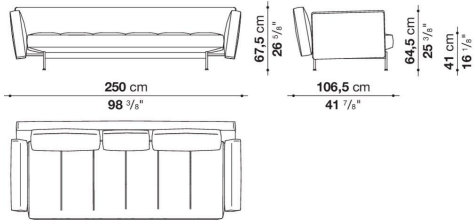

**SK310**

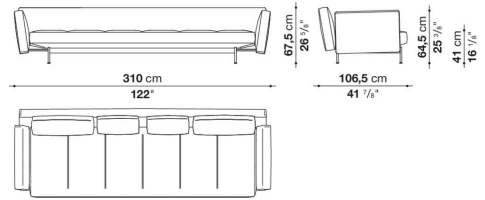

**SK272C**

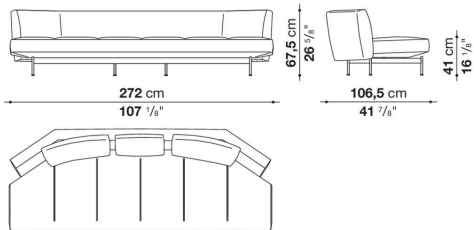

**SK231CS**

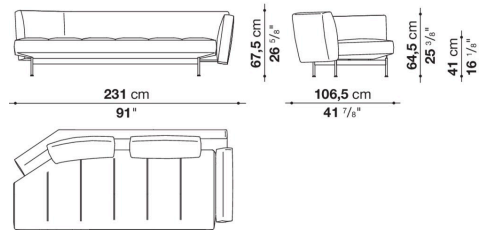

**SK231CD**

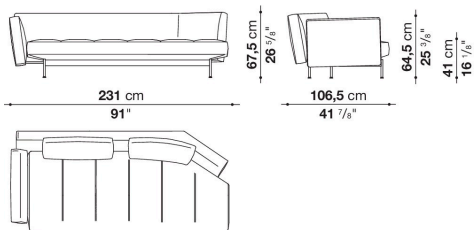

**SK196TS**

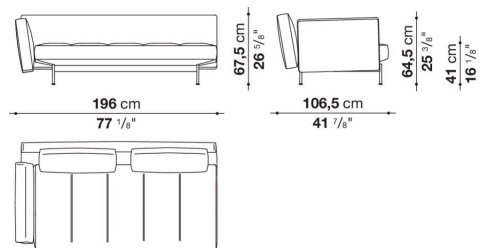

**SK196TD**

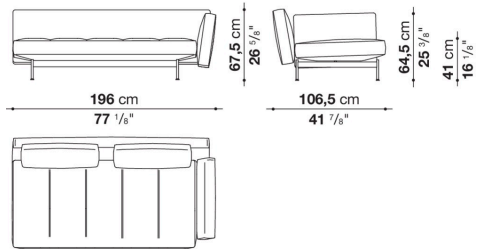

**SK231TS**

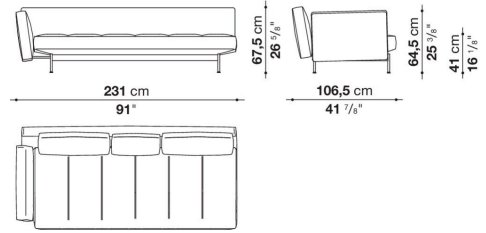

**SK231TD**

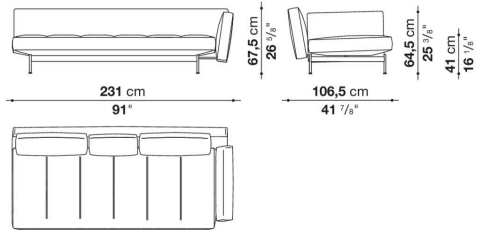

**SK231TAS**

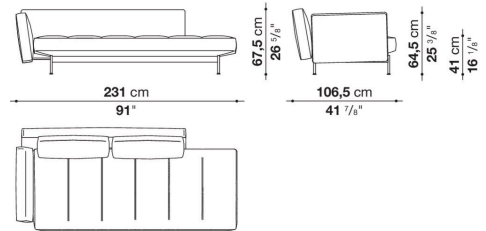

**SK231TAD**

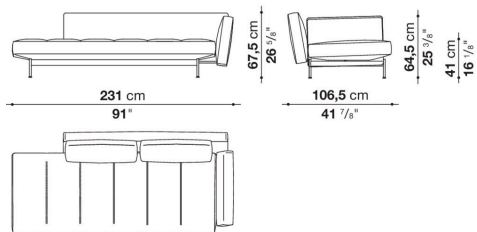

**SK177TCS**

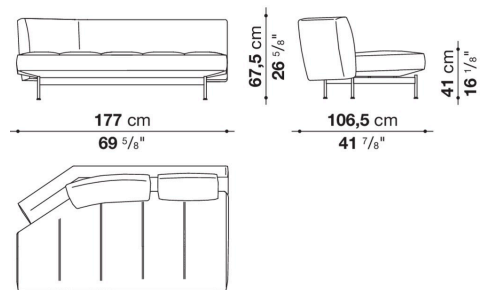

**SK177TCD**

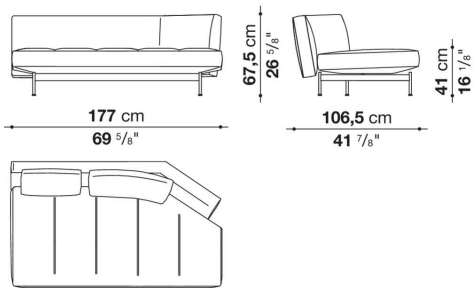

**SK153LS**

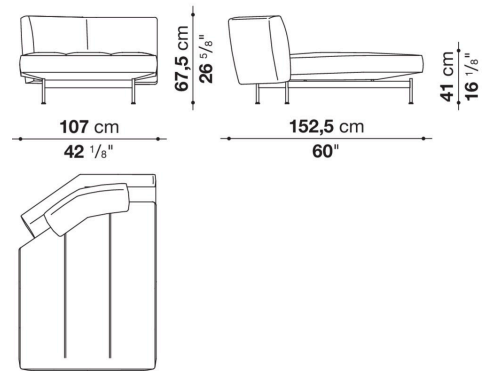

**SK153LD**

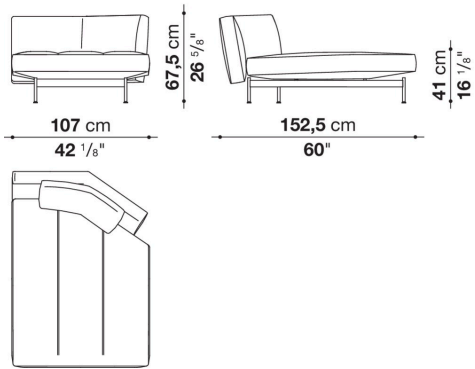

**SK122PQ**

